



Operator's Manual

Z-135/70

CE

with
Maintenance
Information

Second Edition
First Printing
Part No. 114475



Important

Read, understand and obey these safety rules and operating instructions before operating this machine. Only trained and authorized personnel shall be permitted to operate this machine. This manual should be considered a permanent part of your machine and should remain with the machine at all times. If you have any questions, call Genie Industries.

Contents

	Page
Introduction	1
Symbols and Hazard Pictorials Definitions	3
General Safety	5
Personal Safety	7
Work Area Safety	8
Legend	16
Controls	17
Inspections	25
Operating Instructions	38
Transport and Lifting Instructions	49
Maintenance	52
Specifications	55

Contact us:

Internet: <http://www.genielift.com>
e-mail: techpub@genieind.com

Copyright © 2005 by Genie Industries

First Edition: Third Printing, August 2006

Second Edition: First Printing, February 2007

"Genie" and "Z" are registered trademarks of Genie Industries in the U.S.A. and many other countries.

 Printed on recycled paper

Printed in U.S.A.



Introduction

Owners, Users and Operators:

Genie appreciates your choice of our machine for your application. Our number one priority is user safety, which is best achieved by our joint efforts. We feel that you make a major contribution to safety if you, as the equipment users and operators:

- 1 **Comply** with employer, job site and governmental rules.
- 2 **Read, understand and follow** the instructions in this and other manuals supplied with this machine.
- 3 **Use good safe work practices** in a commonsense way.
- 4 **Only have trained/certified operators**, directed by informed and knowledgeable supervision, running the machine.

If there is anything in this manual that is not clear or which you believe should be added, please contact us.

Internet: www.genielift.com

E-mail: techpub@genieind.com



Danger

Failure to obey the instructions and safety rules in this manual will result in death or serious injury.

Do Not Operate Unless:

- You learn and practice the principles of safe machine operation contained in this operator's manual.

1 Avoid hazardous situations.

Know and understand the safety rules before going on to the next section.

- 2 Always perform a pre-operation inspection.
 - 3 Always perform function tests prior to use.
 - 4 Inspect the workplace.
 - 5 Only use the machine as it was intended.
- You read, understand and obey the manufacturer's instructions and safety rules—safety and operator's manuals and machine decals.
 - You read, understand and obey employer's safety rules and work site regulations.
 - You read, understand and obey all applicable governmental regulations.
 - You are properly trained to safely operate the machine.



Introduction

Hazard Classification

Genie uses symbols, color coding and signal words to identify the following:



Safety alert symbol—used to alert you to potential personal injury hazards. Obey all safety messages that follow this symbol to avoid possible injury or death.

▲ DANGER Indicates a hazardous situation which, if not avoided, will result in death or serious injury.

Red

▲ WARNING Indicates a hazardous situation which, if not avoided, could result in death or serious injury.

Orange

▲ CAUTION Indicates a hazardous situation which, if not avoided, could result in minor or moderate injury.

Yellow

NOTICE Indicates a hazardous situation which, if not avoided, could result in property damage.

Blue

Intended Use

This machine is intended to be used only to lift personnel, along with their tools and materials to an aerial work site.

Safety Sign Maintenance









Replace any missing or damaged safety signs. Keep operator safety in mind at all times. Use mild soap and water to clean safety signs. Do not use solvent-based cleaners because they may damage the safety sign material.

Symbol and Hazard Pictorials Definitions

<p>Crush Hazard</p>	<p>Keep away from moving parts.</p>	<p>Electrocution Hazard</p>	<p>Disconnect battery.</p>	<p>Fall Hazard</p>
<p>Keep off this surface.</p>	<p>Crush Hazard</p>	<p>Keep away from path of moving platform.</p>	<p>Tip-over Hazard</p>	<p>Read the operator's manual.</p>
<p>Tip-over Hazard</p>	<p>Rated platform capacity</p>	<p>Electrocution Hazard</p>	<p>Maintain required clearance.</p>	
<p>Explosion Hazard</p>	<p>No smoking. No flame. Stop engine.</p>	<p>Read service manual</p>	<p>Only trained maintenance personnel should access compartments</p>	
<p>Tip-over Hazard</p>	<p>Recovery procedure if tilt alarm sounds while elevated.</p> <p>Platform uphill: 1 Lower primary 2 Retract/lower secondary 3 Retract primary</p> <p>Platform downhill: 1 Retract primary 2 Retract/lower secondary 3 Lower primary</p>		<p>Explosion Hazard</p>	<p>Do not use ether or other high energy starting aids on machines equipped with glow plugs.</p>

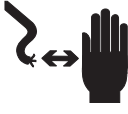
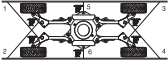
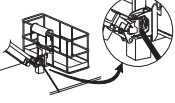
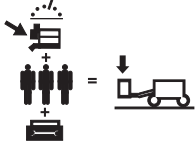

Symbol and Hazard Pictorials Definitions

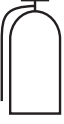
 Lanyard attachment point	 Wheel load	 Voltage rating for power to platform	 Pressure rating for air line to platform	 Tire specification
 Avoid contact.	 Tie-down instructions	 Tie-down instructions	 Weight of welder reduces capacity	 Wind speed
 No step.	 Do not jump-start this battery.	 Fire Hazard	 Fire extinguisher	



General Safety

Safety signs and locations

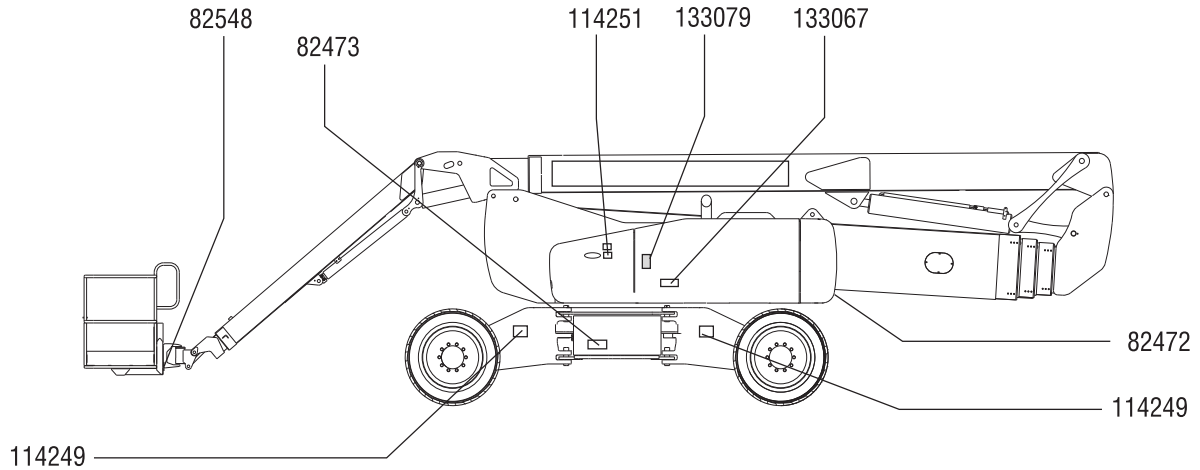

114251



82473



133079



133067

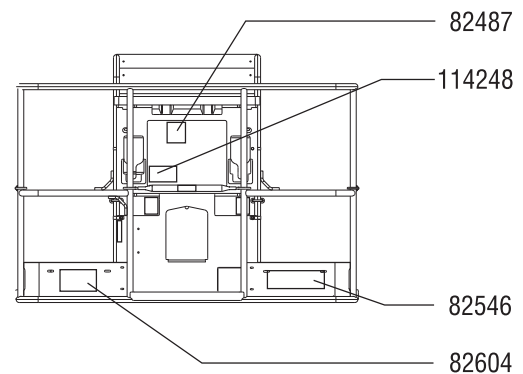

82548



114249

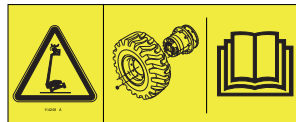

82604

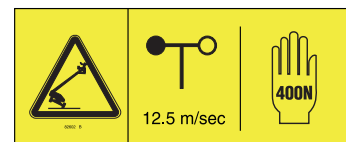

82472



82487



114248



82546



General Safety

Safety signs and locations

114247



82548



133079



114252

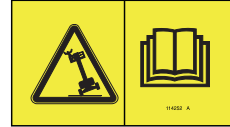

82473



82487



133067



82481



133180



114249

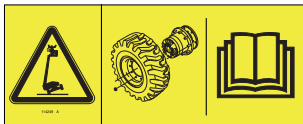

82472

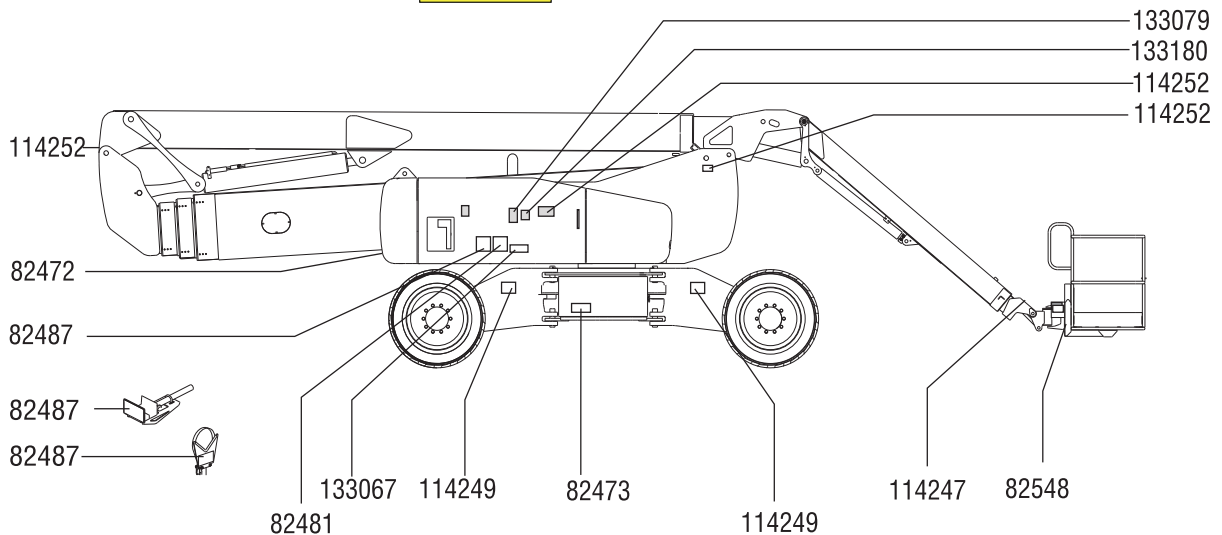



Personal Safety

Fall Protection

Personal fall protection equipment (PFPE) is required when operating this machine.

Occupants must wear a safety belt or harness in accordance with governmental regulations. Attach the lanyard to the anchor provided in the platform.

Operators must comply with employer, job site and governmental rules regarding the use of personal protective equipment.

All PFPE must comply with applicable governmental regulations, and must be inspected and used in accordance with the PFPE manufacturer's instructions.

Work Area Safety

⚠ Electrocuting Hazards

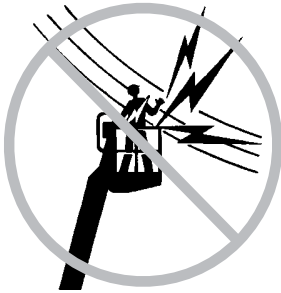

This machine is not electrically insulated and will not provide protection from contact with or proximity to electrical current.

Maintain safe distances from electrical power lines and apparatus in accordance with applicable governmental regulations and the following chart.

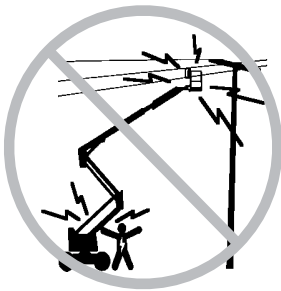

Line Voltage	Required Clearance
0 to 50KV	3.0 m
50 to 200KV	4.6 m
200 to 350KV	6.1 m
350 to 500KV	7.6 m
500 to 750KV	10.6 m
750 to 1000KV	13.7 m

Allow for platform movement, electrical line sway or sag and beware of strong or gusty winds.

Keep away from the machine if it contacts energized power lines. Personnel on the ground or in the platform must not touch or operate the machine until energized power lines are shut off.

Do not use the machine as a ground for welding.

Do not operate the machine during lightning or storms.

Before performing service on this machine, disconnect the batteries under both turntable covers.

⚠ Tip-over Hazards

Occupants, equipment and materials shall not exceed the maximum platform capacity.

Maximum platform capacity	272 kg
Maximum occupants	2

The weight of options and accessories, such as pipe cradles, panel cradles and welders, will reduce the rated platform capacity and must be factored into the total platform load. See the decals with the options.

If using accessories, read, understand and obey the decals and instructions with the accessory.

Work Area Safety

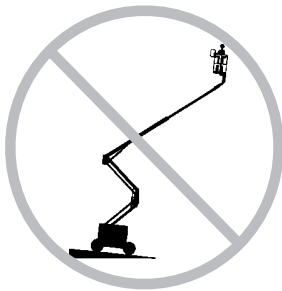

Do not raise or extend the boom unless the machine is on a firm, level surface.

Do not depend on the tilt alarm as a level indicator. The tilt alarm sounds in the platform only when the machine is on a severe slope.

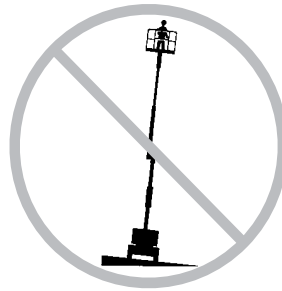

If the tilt alarm sounds while the boom is lowered: Do not extend, rotate or raise the boom above horizontal. Move the machine to a firm, level surface before raising the platform.

If the tilt alarm sounds when the platform is raised: Use extreme caution. Identify the condition of the boom on the slope as shown below. Follow the steps to lower the boom before moving to a firm, level surface. Do not rotate the boom while lowering.

If the tilt alarm sounds with the platform uphill:

- 1 Lower the primary boom.
- 2 Retract/lowe the secondary boom.
- 3 Retract the primary boom.

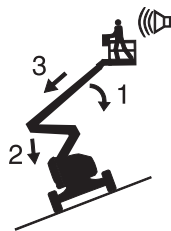

If the tilt alarm sounds with the platform downhill:

- 1 Retract the primary boom.
- 2 Retract/lowe the secondary boom.
- 3 Lower the primary boom.

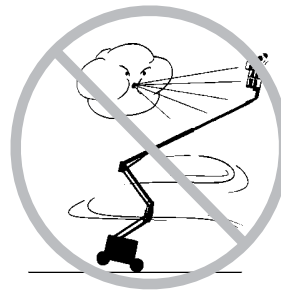
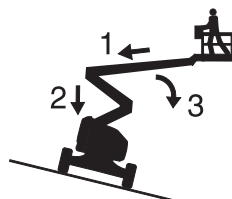

Do not raise the boom when wind speeds may exceed 12.5 m/s. If wind speeds exceed 12.5 m/s when the boom is raised, lower the boom and do not continue to operate the machine.

Do not operate the machine in strong or gusty winds. Do not increase the surface area of the platform or the load. Increasing the area exposed to the wind will decrease machine stability.



Use extreme care and slow speeds while driving the machine in the stowed position across uneven terrain, debris, unstable or slippery surfaces and near holes and drop-offs.

Do not drive the machine on or near uneven terrain, unstable surfaces or other hazardous conditions with the boom raised or extended.

Work Area Safety

Do not use the machine as a crane.

Do not push the machine or other objects with the boom.

Do not contact adjacent structures with the boom.

Do not tie the boom or platform to adjacent structures.

Do not place loads outside the platform perimeter.

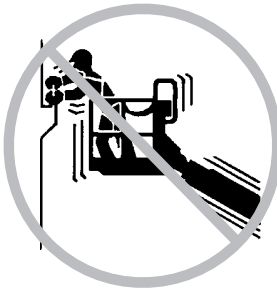

Do not push off or pull toward any object outside of the platform.

Maximum allowable manual force - CE
400 N

Do not alter or disable machine components that in any way affect safety and stability.

Do not replace items critical to machine stability with items of different weight or specification.

Do not replace factory-installed tires with tires of different specification or ply rating.

Do not use the platform controls to free a platform that is caught, snagged or otherwise prevented from normal motion by an adjacent structure. All personnel must be removed from the platform before attempting to free the platform using the ground controls.

Do not use air-filled tires. These machines are equipped with foam-filled tires. Wheel weight is critical to stability.

Do not modify or alter an aerial work platform without prior written permission from the manufacturer. Mounting attachments for holding tools or other materials onto the platform, toeboards or guard rail system can increase the weight in the platform and the surface area of the platform or the load.

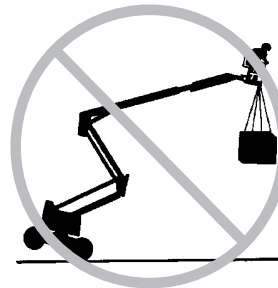

Do not place or attach overhanging loads to any part of this machine.

Do not place ladders or scaffolds in the platform or against any part of this machine.



Do not transport tools and materials unless they are evenly distributed and can be safely handled by person(s) in the platform.

Do not use the machine on a moving or mobile surface or vehicle.

Be sure all tires are in good condition and lug nuts are properly tightened.

Work Area Safety

⚠️ Operation on Slopes Hazards

Do not drive the machine on a slope that exceeds the maximum uphill, downhill or side slope rating of the machine. Slope rating applies only to machines in the stowed position.

Maximum slope rating, stowed position

Platform downhill	45% (24°)
Platform uphill	30% (17°)
Side slope	25% (14°)

Note: Slope rating is subject to ground conditions and adequate traction. See Driving on a Slope in the Operating Instructions Section.

⚠️ Fall Hazards



Occupants must wear a safety belt or harness in accordance with governmental regulations. Attach the lanyard to the anchor provided in the platform.



Do not sit, stand or climb on the platform guard rails. Maintain a firm footing on the platform floor at all times.



Do not climb down from the platform when raised.

Keep the platform floor clear of debris.

Lower the platform entry mid-rail or close the entry gate before operating.

Do not enter or exit the platform unless the machine is in the stowed position and the platform is at ground level.

Work Area Safety

⚠ Collision Hazards



Be aware of limited sight distance and blind spots when driving or operating.

Be aware of the boom position and tailswing when rotating the turntable.

Be aware of machine length when operating. The machine is 12.9 m long.



Check the work area for overhead obstructions or other possible hazards.

Be aware of crushing hazards when grasping the platform guard rail.

Operators must comply with employer, job site and governmental rules regarding the use of personal protective equipment.

Observe and use the color-coded direction arrows on the platform controls and drive chassis for drive and steer functions.



Do not operate a boom in the path of any crane unless the controls of the crane have been locked out and/or precautions have been taken to prevent any potential collision.



No stunt driving or horseplay while operating a machine.

Do not lower the boom unless the area below is clear of personnel and obstructions.



Limit travel speed according to the condition of the ground surface, congestion, slope, location of personnel, and any other factors which may cause collision.

⚠ Bodily Injury Hazard

Do not operate the machine with a hydraulic oil or air leak. An air leak or hydraulic leak can penetrate and/or burn skin.

Always operate the machine in a well-ventilated area to avoid carbon monoxide poisoning.

Improper contact with components under any cover will cause serious injury. Only trained maintenance personnel should access compartments. Access by the operator is only advised when performing a pre-operation inspection. All compartments must remain closed and secured during operation.



Work Area Safety

⚠ Explosion and Fire Hazards

Do not start the engine if you smell or detect liquid petroleum gas (LPG), gasoline, diesel fuel or other explosive substances.

Do not refuel the machine with the engine running.

Refuel the machine and charge the battery only in an open, well-ventilated area away from sparks, flames and lighted tobacco.

Do not operate the machine in hazardous locations or locations where potentially flammable or explosive gases or particles may be present.

Do not spray ether into engines equipped with glow plugs.

⚠ Damaged Machine Hazards

Do not use a damaged or malfunctioning machine.

Conduct a thorough pre-operation inspection of the machine and test all functions before each work shift. Immediately tag and remove from service a damaged or malfunctioning machine.

Be sure all maintenance has been performed as specified in this manual and the appropriate Genie service manual.

Be sure all decals are in place and legible.

Be sure the operator's, safety and responsibilities manuals are complete, legible and in the storage container located on the platform.

⚠ Component Damage Hazards

Do not use any battery or charger greater than 12V to jump-start the engine. Apply jumper cables to the starter and controls battery, not the auxiliary power batteries.

Do not use the machine as a ground for welding unless the machine is equipped with the weld line to platform option and it is properly connected.

⚠ Battery Safety

Burn Hazards

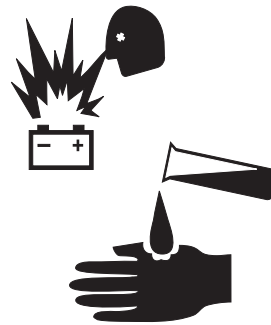

Batteries contain acid. Always wear protective clothing and eye wear when working with batteries.

Avoid spilling or contacting battery acid. Neutralize battery acid spills with baking soda and water.

Explosion Hazard



Keep sparks, flames and lighted tobacco away from batteries. Batteries emit explosive gas.

Electrocution Hazard

Avoid contact with electrical terminals.



Work Area Safety

▲ Pipe Cradle Safety

Read, understand and obey all warnings and instructions provided with the pipe cradles.

Do not exceed the rated platform capacity. The pipe cradle assembly and the weight in the pipe cradles will reduce rated platform capacity and must be factored into total platform load.

The pipe cradle assembly weighs 9.5 kg.

The maximum capacity of the pipe cradle assembly is 91 kg.

The weight of the pipe cradle assembly and the load in the pipe cradles may limit the maximum number of occupants in platform.

Center the load within the perimeter of the platform.

Secure the load to the platform.

Do not obstruct the entrance or the exit of the platform.

Do not obstruct the ability to operate the platform controls or the red Emergency Stop button.

Do not operate unless you are adequately instructed and are aware of all of the hazards associated with movement of the platform with an overhanging load.

Do not cause a horizontal force or side load to the machine by raising or lowering a fixed or overhanging load.

Electrocution Hazard: Keep pipes away from all energized electrical conductors.

▲ Panel Cradle Safety

Read, understand and obey all warnings and instructions provided with the panel cradles.

Do not exceed the rated platform capacity. The combined weight of the cradles, panels, occupants, tools and any other equipment must not exceed rated capacity.

The panel cradle assembly weighs 13.6 kg.

The maximum capacity of the panel cradles is 113 kg.

The weight of the panel cradles and the load in the panel cradles may limit the maximum number of occupants in platform to one person.

Secure the cradles to the platform. Secure the panel(s) to the platform railing using the straps provided.

Do not operate unless you are adequately instructed and are aware of all hazards associated with lifting panels.

Do not cause a horizontal force or side load to machine by raising or lowering a fixed or overhanging load.

Maximum vertical height of panels: 1.2 m

Maximum wind speed: 6.7 m/sec

Maximum panel area: 3 m²



Work Area Safety

⚠ Welder Safety

Read, understand and obey all warnings and instructions provided with the welding power unit.

Do not connect weld leads or cables unless the welding power unit is turned off at the platform controls.

Do not operate unless the weld cables are properly connected and the welder is properly grounded.

The weight of the welder will reduce the rated platform capacity and must be factored into the total platform load. The welder power supply weighs 34 kg.

Do not operate the welder unless a fire extinguisher is immediately available for instant use, per OSHA regulation 1926.352(d).

⚠ Weld Line to Platform Safety

Read, understand and obey all warnings and instructions provided with the welding power unit.

Do not connect weld leads or cables unless the welding power unit is turned off at the platform controls.

Do not operate unless the weld cables are properly connected.

Connect the positive lead to the twist-lock connector at the turntable and platform.

Clamp the negative lead to the ground post at the turntable and platform.

Lockout After Each Use

- 1 Select a safe parking location—firm level surface, clear of obstruction and traffic.
- 2 Retract and lower the boom to the stowed position.
- 3 Rotate the turntable so that the boom is between the non-steer wheels.
- 4 Turn the key switch to the off position and remove the key to secure from unauthorized use.
- 5 Chock the wheels.

Legend

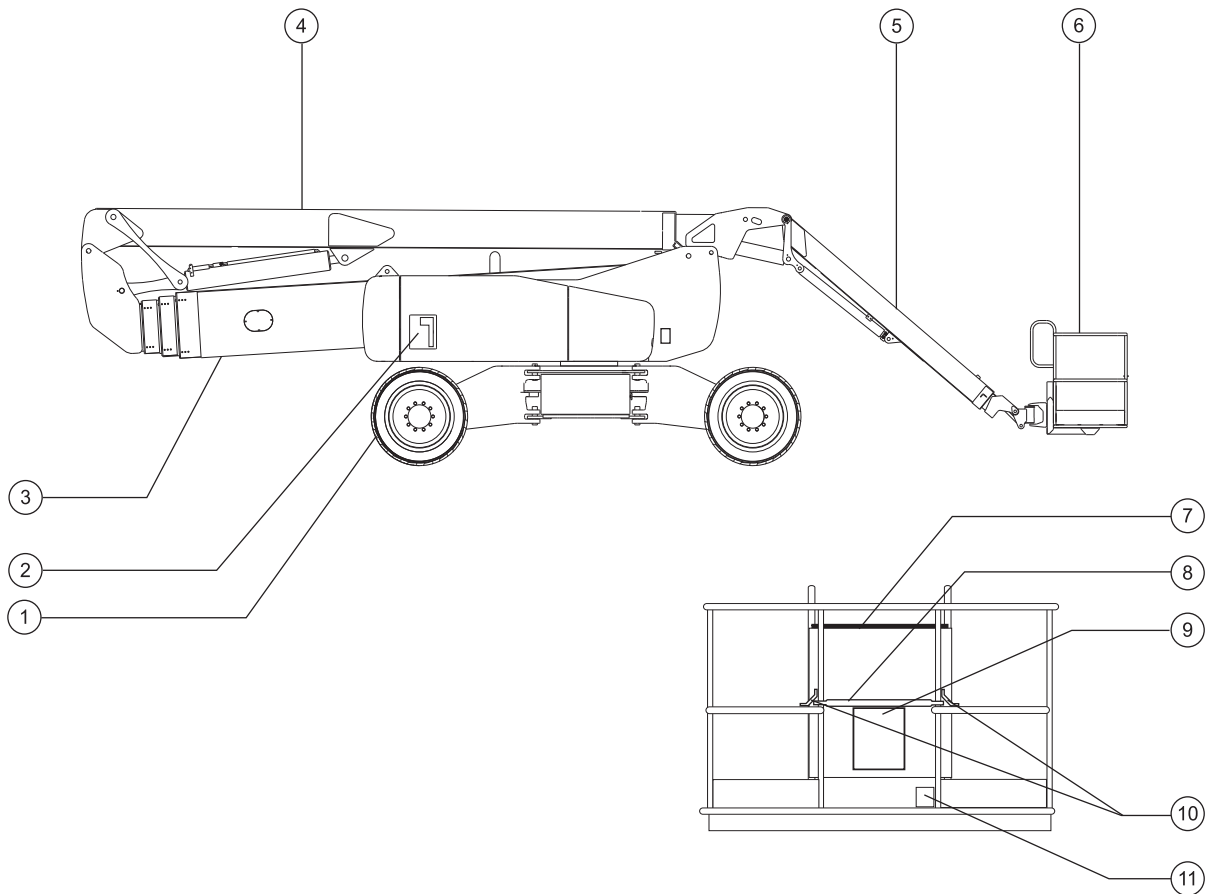

- 1 Square-end tire
- 2 Ground controls
- 3 Secondary boom
- 4 Primary boom
- 5 Jib boom
- 6 Platform
- 7 Platform controls

- 8 Sliding mid-rail
- 9 Manual storage container
- 10 Lanyard anchorage point
- 11 Foot switch

Controls

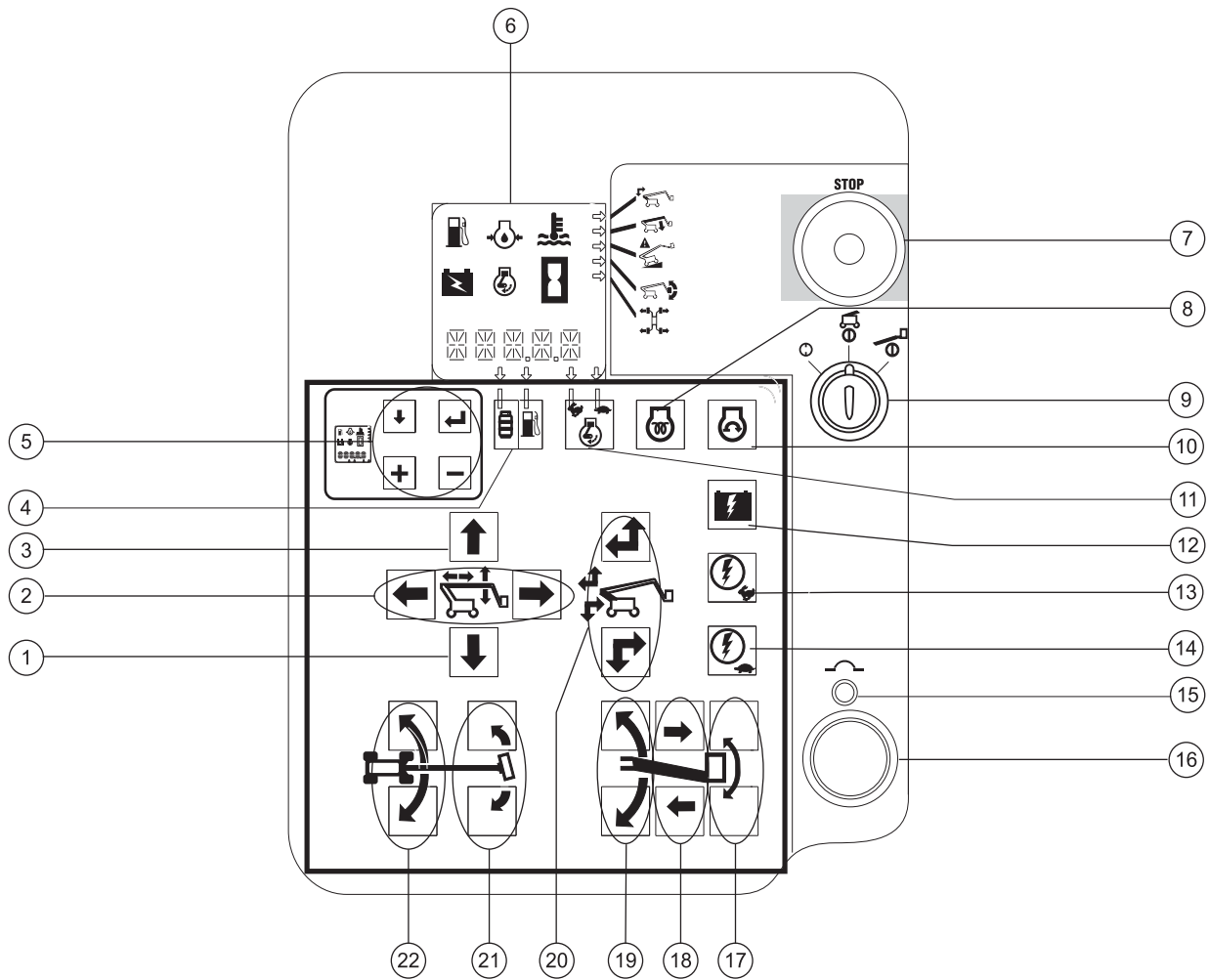











Ground Control Panel

- | | | |
|---------------------------------------|---|--|
| 1 Primary boom down button | 10 Engine start button | 18 Jib boom extend/retract buttons |
| 2 Primary boom extend/retract buttons | 11 Engine speed select button | 19 Jib boom up/down buttons |
| 3 Primary boom up button | 12 Auxiliary power button | 20 Secondary boom up/extend and down/retract buttons |
| 4 Not used | 13 High speed function enable button | 21 Platform rotate left/right buttons |
| 5 LCD screen control buttons | 14 Low speed function enable button | 22 Turntable rotate left/right buttons |
| 6 LCD readout screen | 15 20A circuit breaker for system circuit | |
| 7 Red Emergency Stop button | 16 Alarm | |
| 8 Glow plug button | 17 Platform level up/down buttons | |

Controls

Ground Control Panel

- 1 Primary boom down button
Push the primary boom down button and the primary boom will lower. 
- 2 Primary boom extend/retract buttons
Push the primary boom extend button and the primary boom will extend. 
Push the primary boom retract button and the primary boom will retract. 
- 3 Primary boom up button
Push the primary boom up button and the primary boom will raise. 

- 4 Not used
- 5 LCD screen control buttons
- 6 LCD readout screen
     
a low fuel indicator
b engine oil pressure indicator
c water temperature indicator
d auxiliary power indicator
e high engine rpm indicator
f hour meter
- 7 Red Emergency Stop button
Push in red Emergency Stop button to the off position to stop all functions and turn the engine off. Pull out the red Emergency Stop button to the on position to operate the machine.
- 8 Glow plug button
Push the glow plug button and hold for 3 to 5 seconds.
- 9 Key switch for off/ground/platform selection
Turn the key switch to the off position and the machine will be off. Turn the key switch to the ground position and the ground controls will operate. Turn the key switch to the platform position and the platform controls will operate.
- 10 Engine start button
Push the engine start button and the engine will start.
- 11 Engine speed select button
Push the engine speed select button to select the engine speed. When the arrow above the rabbit is lit, the engine is in high idle speed. When the arrow above the turtle is lit, the engine is in low idle speed.
- 12 Auxiliary power button
Use auxiliary power if the primary power source (engine) fails. Simultaneously push the auxiliary power button and activate the desired function.
- 13 High speed function enable button
Push the high speed function enable switch to enable the functions on the ground control panel to operate at high speed.
- 14 Low speed function enable button
Push the low speed function enable switch to enable the functions on the ground control panel to operate at low speed.
- 15 20A circuit breaker for system circuit
- 16 Alarm

Controls

17 Platform level up/down buttons

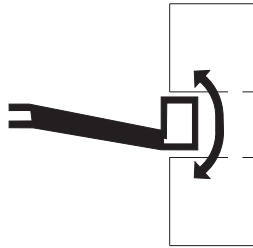
Push the platform level up button and the level of the platform will raise. Push the platform level down button and the level of the platform will lower.



18 Jib boom extend/retract buttons

Push the jib boom extend button and the jib boom will extend. Push the jib boom retract button and the jib boom will retract.

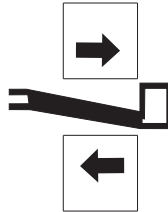

19 Jib boom up/down buttons

Push the jib boom up button and the jib boom will raise. Push the jib boom down button and the jib boom will lower.

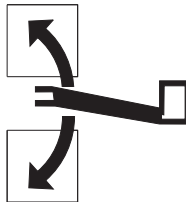

20 Secondary boom up/extend and down/retract buttons

Push the secondary boom up/extend button and the secondary boom will raise and then extend. Push the secondary boom down/retract button and the secondary boom will retract and then lower.



21 Platform rotate left/right buttons

Push the platform rotate left button and the platform will rotate to the left. Push the platform rotate right button and the platform will rotate to the right.

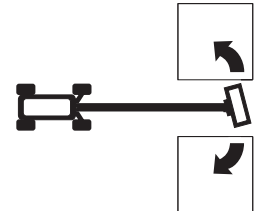

22 Turntable rotate left/right buttons

Push the turntable rotate left button and the turntable will rotate to the left. Push the turntable rotate right button and the turntable will rotate to the right.

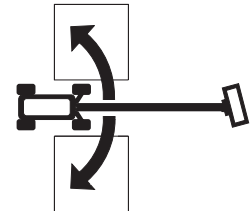

Controls

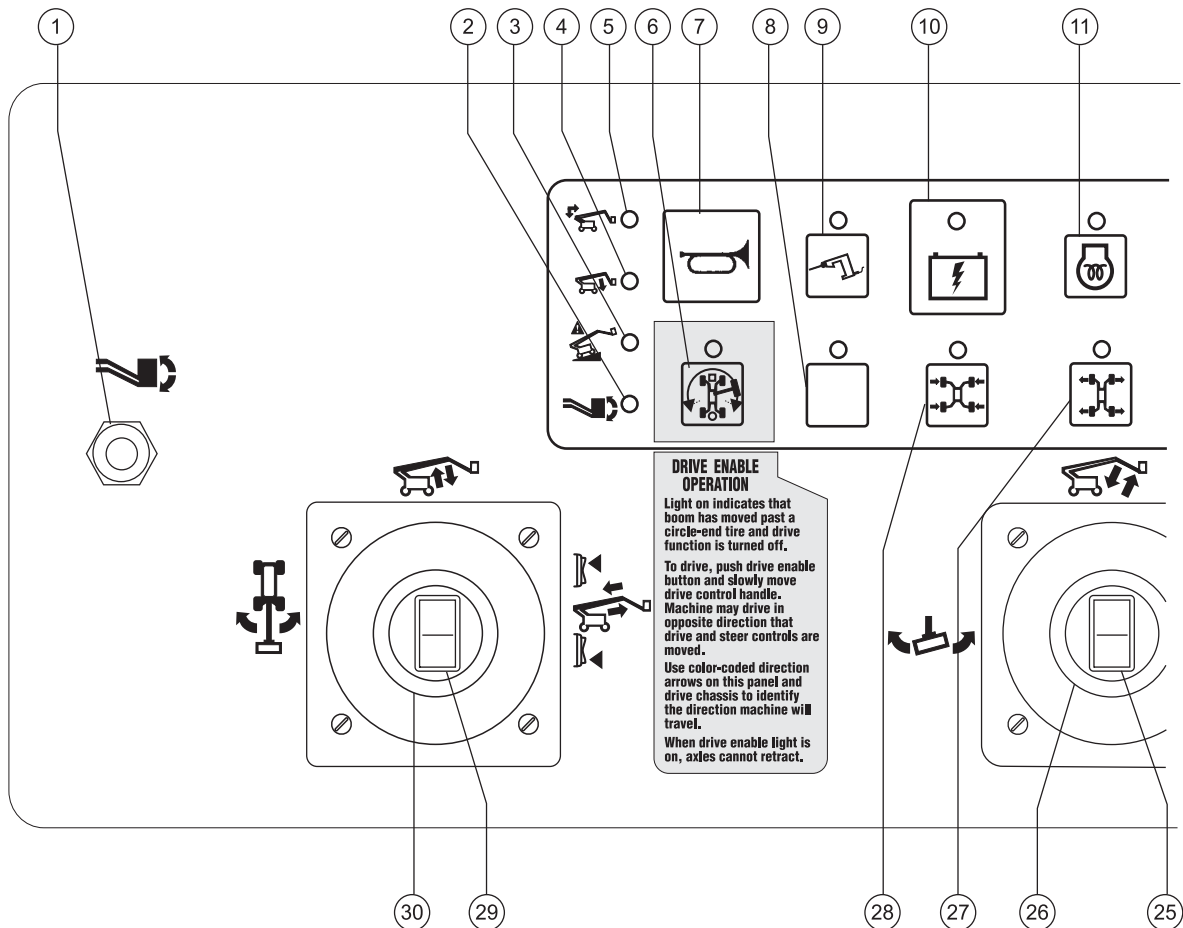

Platform Control Panel

- | | | |
|--|--|---|
| 1 Platform level toggle switch | 8 Used for optional equipment | 14 Engine idle (rpm) select button with indicator lights:
· Rabbit & Foot Switch: foot switch activated high idle
· Turtle: low idle
· Rabbit: high idle |
| 2 Platform not level indicator light | 9 Generator button with indicator light (option) | 15 Platform overload indicator light |
| 3 Machine not level indicator light | 10 Auxiliary power button with indicator light | 16 Not used |
| 4 Lower primary boom indicator light | 11 Glow plug button with indicator light | 17 Fault indicator light |
| 5 Lower/retract secondary boom indicator light | 12 Engine start button with indicator light | 18 Low fuel indicator light |
| 6 Drive enable button with indicator light | 13 Steer mode select buttons with indicator lights | 19 Check engine indicator light |
| 7 Horn button | | 20 Red Emergency Stop button |

Controls

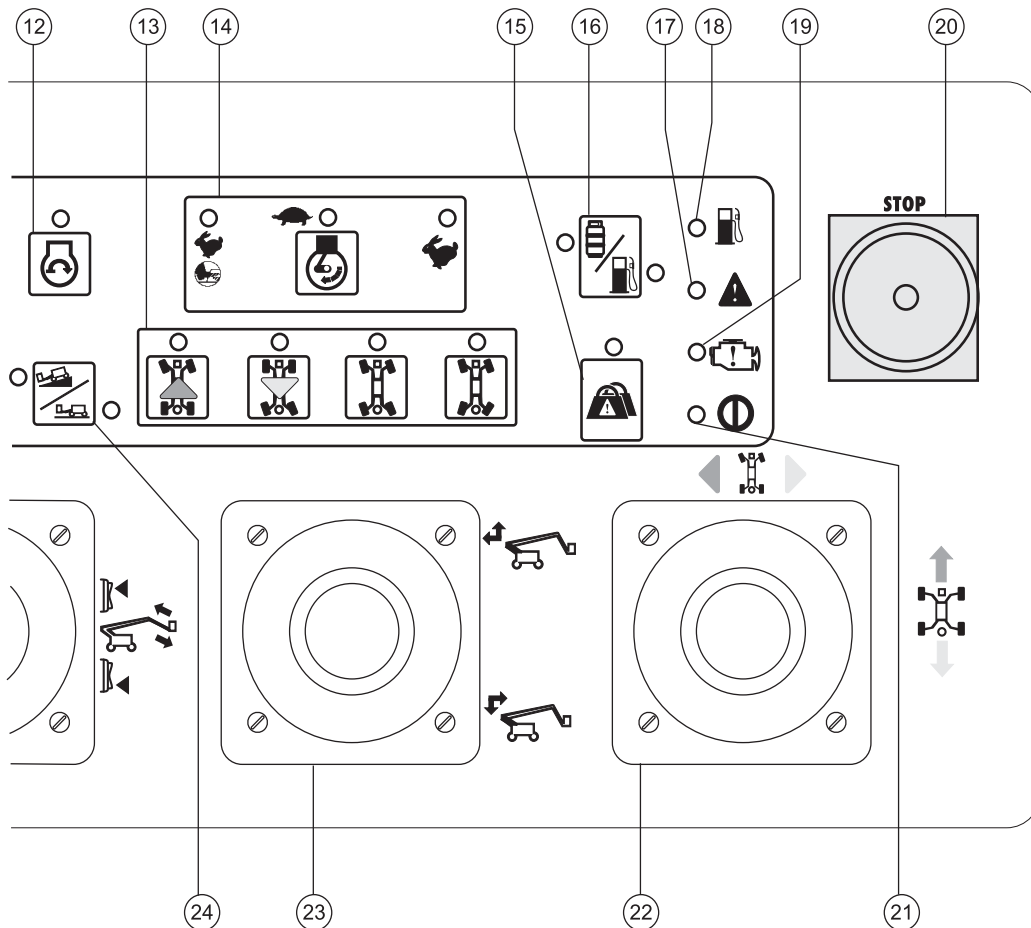

21 Power indicator light

22 Dual axis proportional control handle for drive and steer functions
OR Proportional control handle for drive function and thumb rocker for steer function

23 Single axis proportional control handle for secondary boom up/extend and down/retract function

24 Drive select button with indicator lights:
Machine on incline symbol: Low range operation for inclines
Machine on level surface symbol: High range operation for maximum drive speed

25 Thumb rocker for jib boom extend/retract function

26 Dual axis proportional control handle for jib boom up/down and platform rotate left/right functions

27 Axle extend button with indicator light

28 Axle retract button with indicator light

29 Thumb rocker switch for primary boom extend/retract function

30 Dual axis proportional control handle for primary boom up/down and turntable rotate left/right functions



Controls

Platform Control Panel

1 Platform level toggle switch

Move the platform level switch up and the level of the platform will raise. Move the platform level switch down and the level of the platform will lower.



2 Platform not level indicator light

Level the platform until the light is off. The platform level toggle switch will only work in the direction that will level the platform.

3 Machine not level indicator light

Move the machine to a firm level surface.

4 Lower primary boom indicator light

Lower the primary boom until the light is off.

5 Lower/retract secondary boom indicator light

Lower/retract the secondary boom until the light is off.

6 Drive enable button with indicator light

Light on indicates that the primary boom has moved past either circle-end wheel and the drive function is turned off. To drive, push the drive enable button and slowly move the drive/steer control handle off center.

7 Horn button

8 Used for optional equipment

9 Generator button with indicator light (option)

Press the generator button to turn the generator on. Press the button again to turn the generator off.

10 Auxiliary power button with indicator light

Use auxiliary power if the primary power source (engine) fails.

Simultaneously push the auxiliary power button and activate the desired function. The indicator light will be on when auxiliary power is being used.

11 Glow plug button with indicator light

Push the glow plug button and hold for 3 to 5 seconds. The glow plug indicator light will be on when the glow plugs are being used.

12 Engine start button with indicator light

Push the engine start button and the engine will start. The engine start button indicator light will be on when the button is being pushed.

13 Steer mode select buttons with indicator lights

Push the steer mode select button to choose steer mode. The indicator light next to the current steer mode will be on.

14 Engine idle (rpm) select button with indicator lights

Push the engine idle select button to choose engine rpm setting. The indicator light next to the current setting will be on.

15 Platform overload indicator light

Light flashing indicates the platform is overloaded and no functions will operate.

Remove weight from the platform until the light goes off.

16 Not used

17 Fault indicator light

Light on indicates a system fault.



Controls

18 Low fuel indicator light

Light on indicates the machine is low on fuel.

19 Check engine indicator light

Light on indicates an engine fault.

20 Red Emergency Stop button

Push in red Emergency Stop button to the off position to stop all functions and turn the engine off. Pull out the red Emergency Stop button to the on position to operate the machine.

21 Power indicator light

Light on indicates the machine is on.

22 Dual axis proportional control handle for drive and steer functions

OR

Proportional control handle for drive function and thumb rocker switch for steer function

Move the control handle in the direction indicated by the blue arrow on the control panel and the machine will drive forward. Move the control handle in the direction indicated by the yellow arrow and the machine will drive backwards. Move the control handle in the direction indicated by the blue triangle and the machine will steer to the left. Move the control handle in the direction indicated by the yellow triangle and the machine will steer to the right.

OR

Move the control handle in the direction indicated by the blue arrow on the control panel and the machine will drive forward. Move the control handle in the direction indicated by the yellow arrow and the machine will drive backwards. Press the left side of the rocker switch and the machine will steer to the left. Press the right side of the rocker switch and the machine will steer to the right.

23 Single axis proportional control handle for secondary boom up/extend and down/retract function

Move the control handle up and the secondary boom will raise and then extend. Move the control handle down and the secondary boom will retract and then lower.

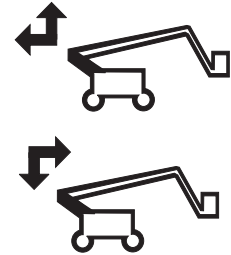

24 Drive select button with indicator lights

Push the drive select button to choose drive setting. The indicator light next to the current setting will be on.

25 Thumb rocker switch for jib boom extend/retract function

Push the top of the rocker switch and the jib boom will retract. Push the bottom of the rocker switch and the jib boom will extend.



26 Dual axis proportional control handle for jib boom up/down and platform rotate left/right functions

Move the control handle up and the jib boom will raise. Move the control handle down and the jib boom will lower. Move the control handle to the left and the platform will rotate to the left. Move the control handle to the right and the platform will rotate to the right.



Controls

27 Axle extend button with indicator light

Push the axle extend button to extend the axles. The indicator light will flash while the axles are extending and stay on when the axles are fully extended.

28 Axle retract button with indicator light

Push the axle retract button to retract the axles. The indicator light will flash while the axles are retracting and stay on when the axles are fully retracted.

29 Thumb rocker switch for primary boom extend /retract function

Push the top of the rocker switch and primary boom will retract. Push the bottom of the rocker switch and the primary boom will extend.



30 Dual axis proportional control handle for primary boom up/down and turntable rotate left/right functions

Move the control handle up and the primary boom will raise. Move the control handle down and the primary boom will lower. Move the control handle to the left and the turntable will rotate to the left. Move the control handle to the right and the turntable will rotate to the right.

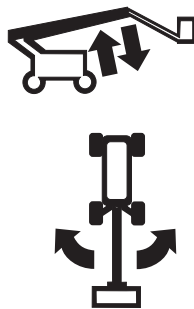



Inspections



Do Not Operate Unless:

- You learn and practice the principles of safe machine operation contained in this operator's manual.
 - 1 Avoid hazardous situations.
 - 2 Always perform a pre-operation inspection.**
 - Know and understand the pre-operation inspection before going on to the next section.**
 - 3 Always perform function tests prior to use.
 - 4 Inspect the workplace.
 - 5 Only use the machine as it was intended.

Pre-operation Inspection Fundamentals

It is the responsibility of the operator to perform a pre-operation inspection and routine maintenance.

The pre-operation inspection is a visual inspection performed by the operator prior to each work shift. The inspection is designed to discover if anything is apparently wrong with a machine before the operator performs the function tests.

The pre-operation inspection also serves to determine if routine maintenance procedures are required. Only routine maintenance items specified in this manual may be performed by the operator.

Refer to the list on the next page and check each of the items.

If damage or any unauthorized variation from factory delivered condition is discovered, the machine must be tagged and removed from service.

Repairs to the machine may only be made by a qualified service technician, according to the manufacturer's specifications. After repairs are completed, the operator must perform a pre-operation inspection again before going on to the function tests.

Scheduled maintenance inspections shall be performed by qualified service technicians, according to the manufacturer's specifications and the requirements listed in the responsibilities manual.



Inspections

Pre-operation Inspection

- Be sure that the operator's, safety and responsibilities manuals are complete, legible and in the storage container located in the platform.
- Be sure that all decals are legible and in place. See Inspections for Decals section.
- Check for engine oil leaks and proper oil level. Add oil if needed. See Maintenance section.
- Check for hydraulic oil leaks and proper oil level. Add oil if needed. See Maintenance section.
- Check for engine coolant leaks and proper level of coolant. Add coolant if needed. See Maintenance section.
- Check for battery fluid leaks and proper fluid level. Add distilled water if needed. See Maintenance section.

Check the following components or areas for damage, improperly installed or missing parts and unauthorized modifications:

- Electrical components, wiring and electrical cables
- Hydraulic hoses, fittings, cylinders and manifolds
- Fuel and hydraulic tanks
- Drive and turntable motors and drive hubs
- Boom wear pads
- Tires and wheels
- Engine and related components
- Limit switches and horn
- Rotation sensors

- Steer and axle sensors
- Alarms and beacons (if equipped)
- Nuts, bolts and other fasteners
- Platform entry mid-rail or gate

Check entire machine for:

- Cracks in welds or structural components
- Dents or damage to machine
- Excessive rust, corrosion or oxidation
- Be sure that all structural and other critical components are present and all associated fasteners and pins are in place and properly tightened.
- After you complete your inspection, be sure that all compartment covers are in place and latched.

Inspections



Do Not Operate Unless:

- ☑ You learn and practice the principles of safe machine operation contained in this operator's manual.

- 1 Avoid hazardous situations.
- 2 Always perform a pre-operation inspection.

3 Always perform function tests prior to use.

Know and understand the function tests before going on to the next section.

- 4 Inspect the workplace.
- 5 Only use the machine as it was intended.

Function Test Fundamentals

The function tests are designed to discover any malfunctions before the machine is put into service. The operator must follow the step-by-step instructions to test all machine functions.

A malfunctioning machine must never be used. If malfunctions are discovered, the machine must be tagged and removed from service. Repairs to the machine may only be made by a qualified service technician, according to the manufacturer's specifications.

After repairs are completed, the operator must perform a pre-operation inspection and function tests again before putting the machine into service.

- 1 Select a test area that is firm, level and free of obstruction.

At the Ground Controls

- 2 Turn the key switch to ground control.
- 3 Pull out the red Emergency Stop button to the on position.
- ⊙ Result: The LCD screen will come on and display no error messages. The beacon (if equipped) should flash.

Note: In cold climates, the LCD readout screen will need to warm up before the display appears.

- 4 Start the engine. See Operating Instructions section.

Test Emergency Stop

- 5 Push in the red Emergency Stop button to the off position.
- ⊙ Result: The engine should turn off and no functions should operate.
- 6 Pull out the red Emergency Stop button to the on position and restart the engine.

Test the Extendable Axles

Note: Start this test with the axles retracted.

- 7 At the ground controls, push and hold a function enable/speed select button and push the primary boom up button.
- ⊙ Result: The primary boom should not raise. On the LCD screen, the arrow next to the extend axle symbol will flash. The boom should not raise unless the axles are extended.



Inspections

- 8 Push and hold a function enable/speed select button and press the secondary boom raise/extend button.
 - ⊙ Result: The secondary boom should not raise. On the LCD screen, the arrow next to the extend axle symbol will flash. The secondary boom should not raise unless the axles are extended.
- 9 Push and hold a function enable/speed select button and press the primary boom extend button.
 - ⊙ Result: The primary boom should not extend. On the LCD screen, the arrow next to the extend axle symbol will flash. The primary boom should not extend unless the axles are extended.
- 10 Push and hold a function enable/speed select button and push the turntable rotate left button.
 - ⊙ Result: The turntable should rotate 15° and then stop. The turntable should not rotate more than 15° unless the axles are extended.
- 11 Push and hold a function enable/speed select button and push the turntable rotate right button.
 - ⊙ Result: The turntable should return to center, rotate 15° to the right and then stop. The turntable should not rotate more than 15° unless the axles are extended.
- 12 Turn the key switch to platform control. At the platform controls, move the drive control handle in the forward direction and push the extend axle button.
 - ⊙ Result: The machine should drive and the axles should extend. The indicator light will flash while the axles are moving and stay on when the axles are fully extended.
- 13 Return to the ground controls. Turn the key switch to ground control.
- 14 Push and hold a function enable/speed select button and push the primary boom up button and then the primary boom down button.
 - ⊙ Result: The primary boom should raise and lower normally.
- 15 Push and hold a function enable/speed select button and push the secondary boom raise/extend button and then the secondary boom lower/retract button.
 - ⊙ Result: The secondary boom should raise and extend and retract and lower normally.
- 16 Push and hold a function enable/speed select button and push the primary boom extend button and then the primary boom retract button.
 - ⊙ Result: The primary boom should extend and retract normally.
- 17 Push and hold a function enable/speed select button and push the turntable rotate left button and then the turntable rotate right button.
 - ⊙ Result: The turntable should rotate normally.



Inspections

Test the Machine Functions

- 18 Do not press and hold a function enable/speed select button. Attempt to activate each boom and platform function button.
- ⦿ Result: No boom and platform functions should operate.
- 19 Press and hold a function enable /speed select button and activate each boom and platform function button.
- ⦿ Result: All boom and platform functions should operate through a full cycle. The descent alarm (if equipped) should sound while the boom is lowering.

Test Auxiliary Controls

- 20 Push in the red Emergency Stop button to the off position to turn off the engine.
- 21 Pull out the red Emergency Stop button to the on position.
- 22 Simultaneously push and hold the auxiliary power button and push each boom function button.



Note: To conserve battery power, test each function through a partial cycle.

- ⦿ Result: All boom functions should operate.
- 23 Start the engine.

Test the Tilt Sensor

- 24 Push one of the LCD screen control buttons until TURNTABLE LEVEL SENSOR X-DIRECTION appears.
- ↓

↶
- ⦿ Result: The LCD screen should display the angle in degrees.
- 25 Push one of the LCD screen control buttons until TURNTABLE LEVEL SENSOR Y-DIRECTION appears.
- ⦿ Result: The LCD screen should display the angle in degrees.
- 26 Push one of the LCD screen control buttons until PLATFORM LEVEL SENSOR DEGREES appears.
- ⦿ Result: The LCD screen should display the angle in degrees.

Inspections

Test the Operating Envelope

- 27 Push one of the LCD screen control buttons shown until PRI BOOM ANGLE TO GRAVITY is displayed.



- 28 Raise the primary boom and observe the LCD screen.

- Result: The primary boom should raise and the LCD screen should display the primary boom angle in degrees.

- 29 Lower the primary boom.

- 30 Simultaneously push the 2 LCD screen control buttons shown to activate status mode.



- 31 Push one of the LCD screen control buttons shown until SEC BOOM ANGLE is displayed.



- 32 Push and hold the secondary boom up/extend button.

- Result: The secondary boom should raise and the LCD screen should display the secondary boom angle in degrees.

The secondary boom should raise and then extend. The secondary boom should not extend until it is fully raised.

- 33 Push and hold the secondary boom down/retract button.

- Result: The secondary boom should fully retract and then lower. The secondary boom should not lower unless it is fully retracted.

At the Platform Controls

Test Emergency Stop

- 34 Turn the key switch to platform control.
- 35 Push in the platform red Emergency Stop button to the off position.

- Result: The engine should turn off and no functions should operate.

- 36 Pull out the red Emergency Stop button and restart the engine.

Test the Horn

- 37 Push the horn button.

- Result: The horn should sound.

Test the Tilt Sensor Alarm

- 38 Push a button, such as the engine RPM button or the fuel select button.

- Result: The alarm should sound at the platform controls.



Inspections

Test the Foot Switch

- 39 Push in the platform red Emergency Stop button to the off position.
- 40 Pull out the red Emergency Stop button to the on position but do not start the engine.
- 41 Press down the foot switch and attempt to start the engine by pushing the engine start button.
- ⦿ Result: The engine should not start.
- 42 Do not press down the foot switch and restart the engine.
- 43 Do not press down the foot switch and test each machine function.
- ⦿ Result: No machine functions should operate.

Test Machine Functions

- 44 Press down the foot switch.
- 45 Activate each machine function control handle, toggle switch or button.
- ⦿ Result: All functions should operate through a full cycle.

Test the Steering

- 46 Push the steer mode select button for square-end (blue arrow) steer.

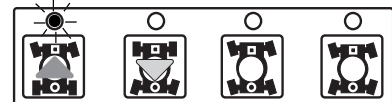

- 47 Press down the foot switch.
- 48 Slowly move the drive/steer control handle in the direction indicated by the blue triangle on the control panel OR press the thumb rocker switch in the direction indicated by the blue triangle.
- ⦿ Result: The square-end wheels should turn in the direction that the blue triangles point on the drive chassis.

- 49 Slowly move the drive/steer control handle in the direction indicated by the yellow triangle on the control panel OR press the thumb rocker switch in the direction indicated by the yellow triangle.

- ⦿ Result: The square-end wheels should turn in the direction that the yellow triangles point on the drive chassis.

- 50 Push the steer mode select button for circle-end (yellow arrow) steer.

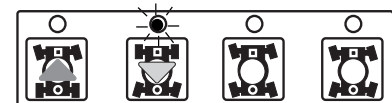

- 51 Press down the foot switch.
- 52 Slowly move the drive/steer control handle in the direction indicated by the yellow triangle on the control panel OR press the thumb rocker switch in the direction indicated by the yellow triangle.
- ⦿ Result: The circle-end wheels should turn in the direction that the blue triangles point on the drive chassis.



Inspections

53 Slowly move the drive/steer control handle in the direction indicated by the blue triangle on the control panel OR press the thumb rocker switch in the direction indicated by the blue triangle.

- Result: The circle-end wheels should turn in the direction that the yellow triangles point on the drive chassis.

54 Push the steer mode select button for crab steer.

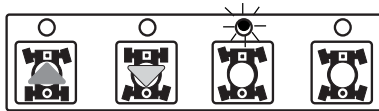

55 Press down the foot switch.

56 Slowly move the drive/steer control handle in the direction indicated by the blue triangle on the control panel OR press the thumb rocker switch in the direction indicated by the blue triangle.

- Result: All wheels should turn in the direction that the blue triangles point on the drive chassis.

57 Slowly move the drive/steer control handle in the direction indicated by the yellow triangle on the control panel OR press the thumb rocker switch in the direction indicated by the yellow triangle.

- Result: All wheels should turn in the direction that the yellow triangles point on the drive chassis.

58 Push the steer mode select button for coordinated steer.

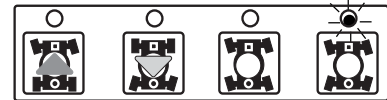

59 Press down the foot switch.

60 Slowly move the drive/steer control handle in the direction indicated by the blue triangle on the control panel OR press the thumb rocker switch in the direction indicated by the blue triangle.

- Result: The square-end wheels should turn in the direction that the blue triangles point on the drive chassis. The circle-end wheels should turn in the direction that the yellow triangles point on the drive chassis.

61 Slowly move the drive/steer control handle in the direction indicated by the yellow triangle on the control panel OR press the thumb rocker switch in the direction indicated by the yellow triangle.

- Result: The square-end wheels should turn in the direction that the yellow triangles point on the drive chassis. The circle-end wheels should turn in the direction that the blue triangles point on the drive chassis.

Inspections

Test Drive and Braking

62 Press down the foot switch.

63 Slowly move the drive/steer control handle in the direction indicated by the blue arrow on the control panel until the machine begins to move, then return the handle to the center position.

⊙ Result: The machine should move in the direction that the blue arrow points on the drive chassis, then come to an abrupt stop.

64 Slowly move the drive/steer control handle in the direction indicated by the yellow arrow on the control panel until the machine begins to move, then return the handle to the center position.

⊙ Result: The machine should move in the direction that the yellow arrow points on the drive chassis, then come to an abrupt stop.

Note: The brakes must be able to hold the machine on any slope it is able to climb.

Test the Drive Enable System

65 Press down the foot switch and lower the booms to the stowed position.

66 Rotate the turntable until the primary boom moves past one of the circle-end tires.

⊙ Result: The drive enable indicator light should come on while the boom is anywhere in the range shown.



67 Move the drive/steer control handle off center.

⊙ Result: No drive function should operate.

68 Push the drive enable button and slowly move the drive/steer control handle off center.

⊙ Result: The drive function should operate.

Note: When the drive enable system is in use, the machine may drive in the opposite direction that the drive and steer control handle is moved.

Use the color-coded direction arrows on the platform controls and the drive chassis to identify the direction of travel.

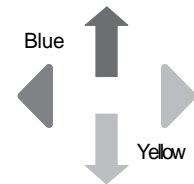

If the drive/steer control handle is not moved within two seconds of pushing the drive enable button, the drive function will not operate.

Test Limited Drive Speed

69 Press down the foot switch.

70 Raise the primary boom to 5° above horizontal.

71 Slowly move the drive control handle to the full drive position.

⊙ Result: The maximum achievable drive speed with the primary boom raised should not exceed 30 cm per second.

Note: The machine will travel 12 m in 40 seconds.

72 Lower the primary boom to the stowed position.

73 Extend the primary boom 1.2 m.

74 Slowly move the drive control handle to the full drive position.

⊙ Result: The maximum achievable drive speed with the primary boom extended should not exceed 30 cm per second.

Note: The machine will travel 12 m in 40 seconds.



Inspections

75 Retract the primary boom to the stowed position.

76 Raise the secondary boom to 5° above horizontal.

77 Slowly move the drive control handle to the full drive position.

- ⦿ Result: The maximum achievable drive speed with the secondary boom raised should not exceed 30 cm per second.

Note: The machine will travel 12 m in 40 seconds.

78 Lower the secondary boom to the stowed position.

79 Extend the jib boom 30 cm.

80 Slowly move the drive control handle to the full drive position.

- ⦿ Result: The maximum achievable drive speed with the jib boom extended should not exceed 30 cm per second.

If the drive speed with the primary or secondary boom raised or extended or the jib boom extended exceeds 1 foot / 30 cm per second, immediately tag and remove the machine from service.

81 Extend the primary boom 1.2 m.

82 Slowly move the drive control handle to the full drive position.

- ⦿ Result: The maximum achievable drive speed with the jib boom extended and the primary boom extended should not exceed 6 inches / 15 cm per second.

If the drive speed with the jib boom extended and the primary boom extended exceeds 15 cm per second, immediately tag and remove the machine from service.

83 Retract the primary boom and the jib boom.

Test Auxiliary Controls

84 Push in the red Emergency Stop button to the off position to shut off the engine.

85 Pull out the red Emergency Stop button to the on position.

86 Press down the foot switch.

87 Simultaneously press and hold the auxiliary power button and activate each function control handle, toggle switch or button.

Note: To conserve battery power, test each function through a partial cycle.

- ⦿ Result: All boom and steer functions should operate.

Test Aircraft Protection Package (if equipped)

88 Move the gray bumper at the bottom of the platform 10 cm in any direction.

89 Activate each function control handle or toggle switch or button.

- ⦿ Result: All boom and steer functions should not operate.

90 Push and hold the function override button.

91 Activate each function control handle or toggle switch or button.

- ⦿ Result: All boom and steer functions should operate.

Inspections



Do Not Operate Unless:

- You learn and practice the principles of safe machine operation contained in this operator's manual.

- 1 Avoid hazardous situations.
- 2 Always perform a pre-operation inspection.
- 3 Always perform function tests prior to use.

4 Inspect the workplace.

Know and understand the workplace inspection before going on to the next section.

- 5 Only use the machine as it was intended.

Workplace Inspection

Be aware of and avoid the following hazardous situations:

- drop-offs or holes
- bumps, floor obstructions or debris
- sloped surfaces
- unstable or slippery surfaces
- overhead obstructions and high voltage conductors
- hazardous locations
- inadequate surface support to withstand all load forces imposed by the machine
- wind and weather conditions
- the presence of unauthorized personnel
- other possible unsafe conditions

Fundamentals

The workplace inspection helps the operator determine if the workplace is suitable for safe machine operation. It should be performed by the operator prior to moving the machine to the workplace.

It is the operator's responsibility to read and remember the workplace hazards, then watch for and avoid them while moving, setting up and operating the machine.



Inspections

Inspection for Decals with Symbols

Determine whether the decals on your machine have words or symbols. Use the appropriate inspection to verify that all decals are legible and in place.

Part No.	Description	Quantity
27204	Arrow - Blue	2
27205	Arrow - Yellow	2
27206	Triangle - Blue	2
27207	Triangle - Yellow	2
28159	Label - Diesel	1
28174	Label - Power to Platform, 230V	2
28235	Label - Power to Platform, 115V	2
40434	Label - Lanyard Anchorage	3
44981	Label - Air Line to Platform	2
65278	Label - No Step	2
82246	Label - 113 dB	1
82422	Label - Driving Lights	1
82472	Label - Crushing Hazard	2
82473	Label - Compartment Access	2
82481	Label - Battery Safety	1
82487	Label - Read the Manual	2
82487	Label - Read the Manual, Pipe Cradle	1
82487	Label - Read the Manual, Panel Cradle	1
82546	Notice - Max. Capacity, 272 kg	1
82548	Label - Platform Rotate	2
82604	Label - Max. Side Force, 400N	1

Part No.	Description	Quantity
82840	Ground Control Panel	1
82841	Platform Control Panel	1
97705	Cosmetic - Genie Z-135/70	1
97716	Label - Wheel Load	4
97757	Label - Hydraulic Oil Level	1
97815	Label - Lower Mid-Rail	1
97889	Cosmetic - Z-135	2
97891	Cosmetic - Genie Z-135	1
114247	Label - Fall Hazard	1
114248	Label - Tip-over Hazard	1
114249	Label - Tire Specifications	4
114251	Label - No Smoking	1
114252	Label - Tip-over Hazard	3
133067	Label - Electrocutation Hazard	2
133180	Label - Battery Damage	1
133205	Label - Electrocutation/Burn Hazard	2
1000054	Label - Drive Enable Patch	1
1000257	Label - Transport Diagram	2

 Shading indicates decal is hidden from view, i.e. under covers

Inspections

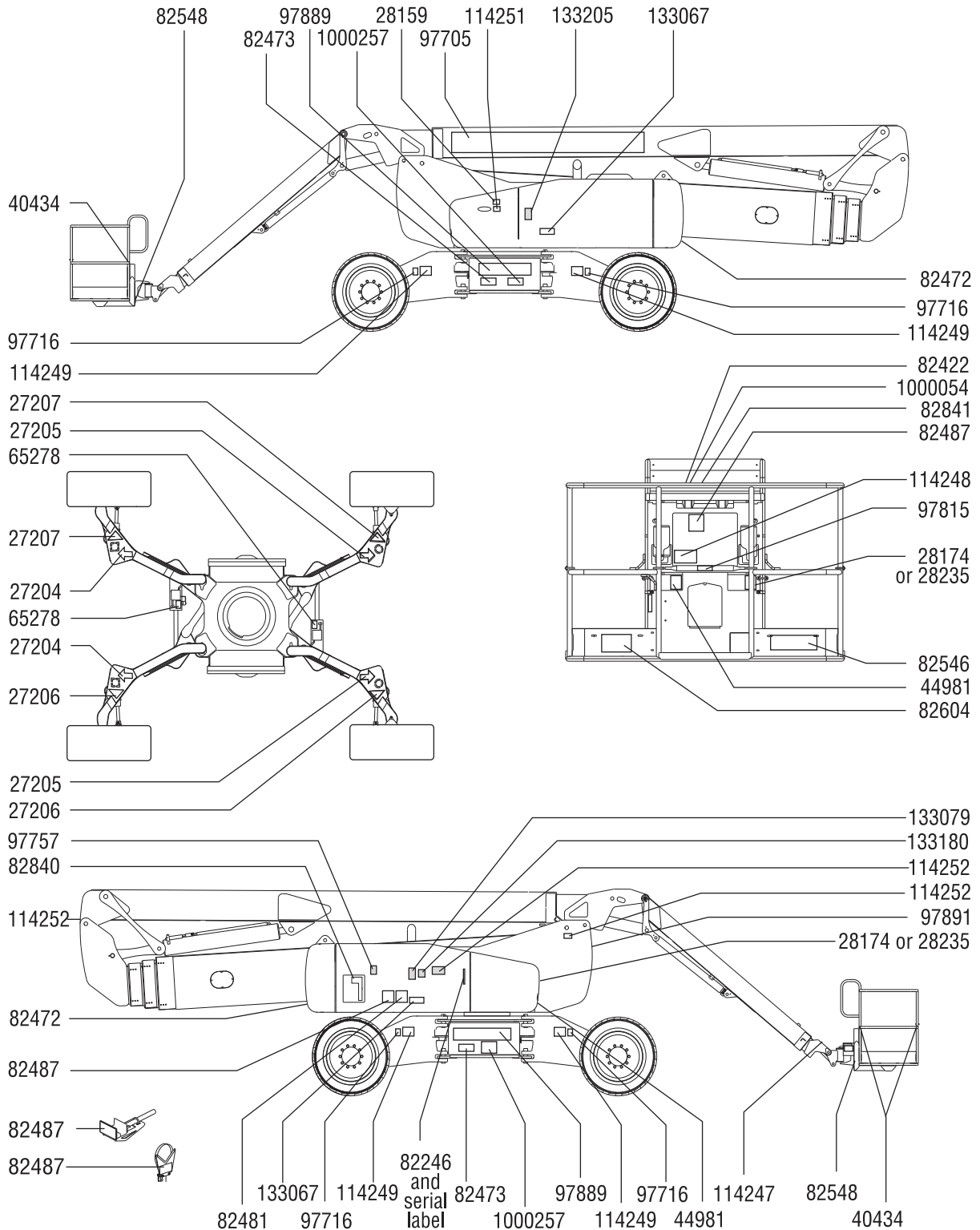

Operating Instructions



Do Not Operate Unless:

- You learn and practice the principles of safe machine operation contained in this operator's manual.
 - 1 Avoid hazardous situations.
 - 2 Always perform a pre-operation inspection.
 - 3 Always perform function tests prior to use.
 - 4 Inspect the workplace.
 - 5 Only use the machine as it was intended.**

Fundamentals

The Operating Instructions section provides instructions for each aspect of machine operation. It is the operator's responsibility to follow all the safety rules and instructions in the operator's, safety and responsibilities manuals.

Using the machine for anything other than lifting personnel, along with their tools and materials, to an aerial work site is unsafe and dangerous.

Only trained and authorized personnel should be permitted to operate a machine. If more than one operator is expected to use a machine at different times in the same work shift, they must all be qualified operators and are all expected to follow all safety rules and instructions in the operator's, safety and responsibilities manuals. That means every new operator should perform a pre-operation inspection, function tests, and a workplace inspection before using the machine.

Operating Instructions

Starting the Engine

- 1 At the ground controls, turn the key switch to the desired position.

Deutz models

- 2 Press the glow plug button. The glow plugs will turn on for 30 seconds.
- 3 Press the engine start button. The engine start button can be pressed at any time while the glow plugs are on. If the engine fails to start or dies, the restart delay will disable the start switch for 3 seconds.



Perkins and Cummins models

- 2 Press and hold the glow plug button.
- 3 Press the engine start button. If the engine fails to start or dies, the restart delay will disable the start switch for 3 seconds.

If the engine fails to start after 15 seconds of cranking, determine the cause and repair any malfunction. Wait 60 seconds before trying to start again.

In cold conditions, -6°C and below, warm the engine for 5 minutes before operating to prevent hydraulic system damage.

In extreme cold conditions, -18°C and below, machines should be equipped with optional cold start kits. Attempting to start the engine when temperatures are below -18°C may require the use of a booster battery.

If the machine is stored for long periods of time in low temperatures (below 0°C) with the secondary boom raised and extended, the engine may not start due to a system fault.

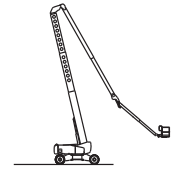

To remove the fault, hold the auxiliary power button and activate the secondary boom up function until the secondary boom begins extending.

Emergency Stop

Push in either the ground or platform red Emergency Stop button to the off position to stop all functions and turn the engine off.

Repair any function that operates when the red Emergency Stop button is pushed in to the off position.

Selecting and operating the ground controls will override the platform red Emergency Stop button.

Auxiliary Controls

Use auxiliary power if the primary power source (engine) fails.

- 1 Turn the key switch to ground or platform control.
- 2 Pull out the red Emergency Stop button to the on position.
- 3 Press down the foot switch when operating the auxiliary controls from the platform.
- 4 Simultaneously hold the auxiliary power button and activate the desired function.



Operating Instructions

To Extend and Retract Axles

- 1 Turn the key switch to platform control.
- 2 At the platform controls, press down the foot switch and move the drive control handle in either direction and push the appropriate axle button.

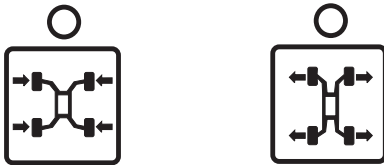

The indicator light will flash while the axles are moving and stay on when the axles are fully extended or retracted.

The axles can only be retracted if the primary and secondary booms are fully lowered and retracted and the platform is between the circle-end wheels.

Operation from Ground

- 1 Turn the key switch to ground control.
- 2 Pull out the red Emergency Stop button to the on position.
- 3 Start the engine.

To Position Platform

- 1 Push and hold a function enable/speed select button.
- 2 Push the appropriate function button according to the markings on the control panel.

Drive, steer and axle functions are not available from the ground controls.

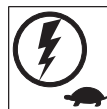

Operation from Platform

- 1 Turn the key switch to platform control.
- 2 Pull out both ground and platform red Emergency Stop buttons to the on position.
- 3 Start the engine. Do not press down the foot switch when starting the engine.

To Position Platform

- 1 Press down the foot switch.
- 2 Slowly move the appropriate function control handle or toggle switch or press the appropriate button according to the markings on the control panel.

To Steer

- 1 Press down the foot switch.
- 2 Select the steer mode by pressing a steer mode button. The indicator light next to the current steer mode will be on.

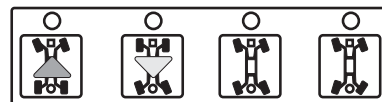

- 3 Slowly move the drive/steer control handle in the direction indicated by the blue or yellow triangles OR press the thumb rocker switch located on top of the drive control handle.



Use the color-coded direction arrows on the platform controls and the drive chassis to identify the direction the wheels will turn.

Operating Instructions

To Drive

- 1 Press down the foot switch.
- 2 Increase speed: Slowly move the drive/steer control handle in the direction indicated by the blue or yellow arrows.



Decrease speed: Slowly move the drive/steer control handle toward center.

Stop: Return the drive/steer control handle to center or release the foot switch.

Use the color-coded direction arrows on the platform controls and the drive chassis to identify the direction the machine will travel.

Machine travel speed is restricted when the boom is raised or extended.

Driving on a slope

Determine the uphill, downhill and side slope ratings for the machine and determine the slope grade.



Maximum slope rating, counterweight uphill (gradeability): 45% (24°)



Maximum slope rating, counterweight downhill: 30% (17°)



Maximum side slope rating: 25% (14°)

Note: Slope rating is subject to ground conditions and adequate traction. The term gradeability applies to the counterweight uphill configuration only.

Be sure the boom is below horizontal and the platform is between the circle-end wheels.

Move the drive speed select switch to machine on incline symbol.

Operating Instructions

To determine the slope grade:

Measure the slope with a digital inclinometer OR use the following procedure.

You will need:

- carpenter's level
- straight piece of wood, at least 3 feet / 1 m long
- tape measure

Lay the piece of wood on the slope.

At the downhill end, lay the level on the top edge of the piece of wood and lift the end until the piece of wood is level.

While holding the piece of wood level, measure the vertical distance from the bottom of the piece of wood to the ground.

Divide the tape measure distance (rise) by the length of the piece of wood (run) and multiply by 100.

Example:

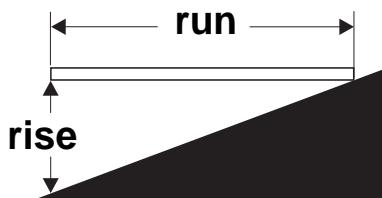

Piece of wood = 3.6 m

Run = 144 inches 3.6 m

Rise = 12 inches 0.3 m

$0.3 \text{ m} \div 3.6 \text{ m} = 0.083 \times 100 = 8.3\% \text{ grade}$

If the slope exceeds the maximum uphill, downhill or side slope rating, then the machine must be winched or transported up or down the slope. See the Transport and Lifting section.

Drive Enable

Light on indicates that the primary boom has moved past either circle-end wheel and the drive function is turned off.

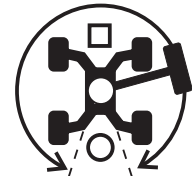

To drive, push the drive enable button and slowly move the drive/steer control handle off center.

If the drive/steer control handle is not moved within two seconds of pushing the drive enable button, the drive function will not operate. Release and push the drive enable button again.

Be aware that the machine may move in the opposite direction that the drive and steer controls are moved.

Always use the color-coded direction arrows on the platform controls and the drive chassis to identify the direction the machine will travel.

When the drive enable light is on, the axles cannot retract.

Operating Instructions

Engine Idle Select (rpm)

Select the engine idle (rpm) by pressing the select button. The indicator light next to the current setting will be on.



- Rabbit and foot switch symbol: foot switch activated high idle
- Turtle symbol: low idle
- Rabbit symbol: high idle

Check Engine Light



Light on and engine stopped: Tag the machine and remove from service.

Light on and engine still running: Contact service personnel within 24 hours.

Operating Envelope Indicator Lights

The operating envelope indicator lights will come on to notify the operator that a function has been interrupted and/or an action is required by the operator.

Lower/Retract Secondary Boom indicator light flashing: Lower/retract the secondary boom until the indicator light is off.



Lower Primary Boom indicator light flashing: Lower the primary boom until the indicator light is off.



Machine Not Level indicator light flashing: The tilt alarm will be sounding when this light is flashing. Move the machine to a firm, level surface.



Platform Not Level indicator light flashing: The tilt alarm will be sounding when this light is flashing. The Platform Level toggle switch will only work in the direction that will level the platform. Level the platform until the indicator light is off.



Out of Operational Envelope Recovery

If all functions stop operating, you may have exceeded the operational envelope. A trained operator on the ground will need to lower the platform from the ground controls. Please see the Service Bypass / Recovery Key Switch section in the service manual.

Operating Instructions

Generator (if equipped)

To operate the generator, press the generator button. The indicator light will come on and the engine will continue to run.

Plug power tools into the power to platform GFCI outlet.

To turn off the generator, push the generator button. The indicator light will turn off.

Aircraft Protection Package (if equipped)

If the platform bumpers come in contact with aircraft components, the machine will shut down and no functions will operate.

Move the function override toggle switch to either side to operate the machine.

Platform Overload Indicator Light



Light flashing indicates the platform is overloaded and no functions will operate.

Remove weight from the platform until the light goes off.

After Each Use

- 1 Select a safe parking location—firm level surface, clear of obstruction and traffic.
- 2 Retract and lower the boom to the stowed position.
- 3 Rotate the turntable so that the boom is between the circle-end wheels.
- 4 Turn the key switch to the off position and remove the key to secure from unauthorized use.
- 5 Chock the wheels.

Operating Instructions

Pipe Cradle Instructions

The pipe cradle assembly consists of 2 pipe cradles positioned at either side of the platform and mounted to the guardrails with U-bolts.

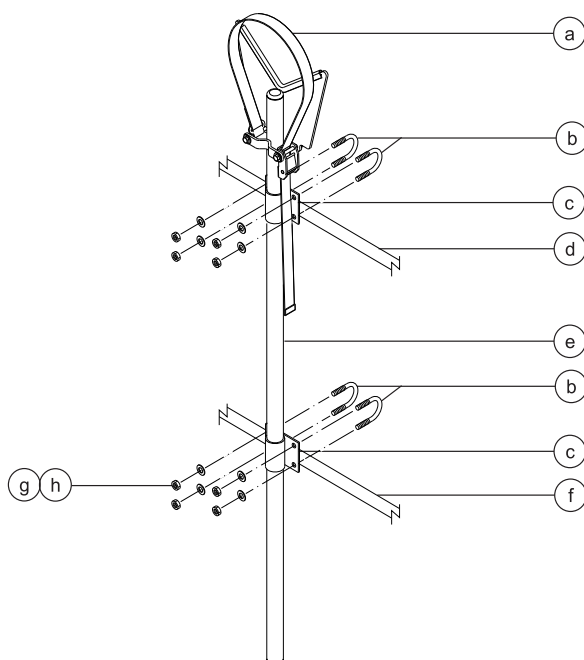

- | | |
|--------------------------|---------------------------|
| a strap | e pipe cradle weldment |
| b U-bolts | f middle platform railing |
| c pipe cradle mount | g flat washers |
| d upper platform railing | h 3/8-inch nylock nuts |

Observe and Obey:

- Pipe cradles must be installed on the inside of the platform.
- Pipe cradles must not obstruct the platform controls or the platform entrance.
- The bottom of the pipe cradle tube must rest on the platform floor.
- Be sure the platform is level before installing a pipe cradle.

Pipe Cradle Installation

- 1 Install a pipe cradle on each side of the platform. Refer to the illustration on the left. Make sure the bottom of the pipe cradle tube rests on the platform floor.
- 2 Install two U-bolts from the outside of the platform rails through each pipe cradle mount.
- 3 Secure each U-bolt with 2 washers and 2 nuts.



Operating Instructions

Pipe Cradle Operation

- 1 Be sure the pipe cradle assembly and installation instructions have been followed properly and that the pipe cradles are secured to the platform railings.
- 2 Place the load so that it rests in both pipe cradles. The length of the load should be parallel with the length of the platform.
- 3 Center the load in the pipe cradles.
- 4 Secure the load to each pipe cradle. Pass the nylon strap over the load. Depress the buckle and slide the strap through. Tighten the strap.
- 5 Gently push and pull on the load to make sure the pipe cradles and load are secure.
- 6 Keep the load secured when the machine is moving.

⚠ Tip-over hazard. The weight of the pipe cradle assembly and the load in the pipe cradles will reduce the rated platform capacity of the machine and must be factored into the total platform load.

⚠ Tip-over hazard. The weight of the pipe cradle assembly and the load in the pipe cradles may limit the maximum number of occupants in the platform.

Maximum Pipe Cradle Capacity	
All models	90.7 kg
Pipe Cradle Assembly Weight	
	9.5 kg



Operating Instructions

Panel Cradle Assembly

- 1 Apply the warning decal to the front of each panel cradle (if needed).
- 2 Install rubber bumper 1 in the panel cradle base. See the illustration.
- 3 Secure the bumper with 2 high profile lock nuts and 2 washers.

Panel Cradle Installation

- 1 Insert the hook piece through the slots in the panel cradle base.
- 2 Hook the panel cradle to the bottom platform tube in the desired location.
- 3 Install rubber bumper 2 through the panel cradle base and the hook piece. See the illustration.
- 4 Secure with 2 low profile lock nuts.
- 5 If the panel cradle is installed at a platform floor support tube, insert the U-bolt through the floor, around the tube and into the panel cradle base.
- 6 Secure the U-bolt with 2 nuts and 2 washers. Proceed to step 9.
- 7 If the panel cradle is not installed at a platform floor support tube, use the aluminum tube provided.
- 8 Place the tube between the panel cradle and the platform floor. Insert the U-bolt through the floor, around the tube and into the panel cradle base.
- 9 Repeat above for the second set of parts.

Installation of Padding

- 1 Install the 2 pieces of padding on the platform rails. Position the padding to protect the panels from contact with the platform rails.

Installation of Strap

- 1 Open the clamp and install it around a vertical platform rail tube.
- 2 Insert a bolt with a washer through one side of the clamp.
- 3 Install the strap assembly end plate onto the bolt.
- 4 Insert the bolt through the other side of the clamp.
- 5 Secure with a washer and a nut. Do not over-tighten. The strap assembly end plate should be able to slide on the platform rail.

Operating Instructions

Panel Cradle Operation

- 1 Secure both panel cradles to the platform.
- 2 Place the load so that it rests in both panel cradles.
- 3 Center the load on the platform.
- 4 Secure the load to the platform using the strap. Tighten the strap.

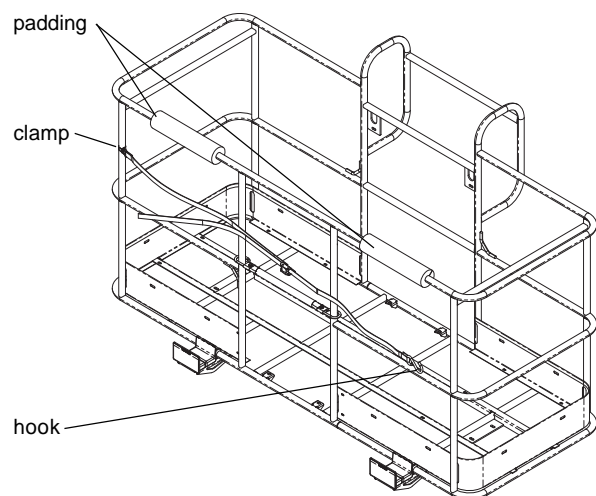
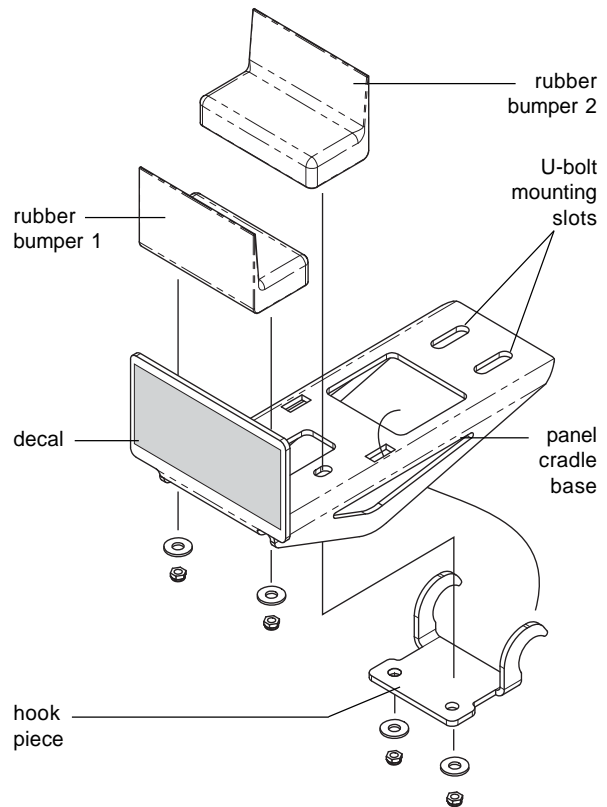



Observe and Obey:

- ☑ Genie Industries provides this securement information as a recommendation. Drivers are solely responsible for making sure machines are properly secured and the correct trailer is selected pursuant to US Department of Transportation regulations, other localized regulations, and their company policy.
- ☑ Genie customers needing to containerize any lift or Genie product should source a qualified freight forwarder with expertise in preparing, loading and securing construction and lifting equipment for international shipment.
- ☑ Only qualified aerial lift operators should move the machine on or off the truck.
- ☑ The transport vehicle must be parked on a level surface.
- ☑ The transport vehicle must be secured to prevent rolling while the machine is being loaded.
- ☑ Be sure the vehicle capacity, loading surfaces and chains or straps are sufficient to withstand the machine weight. See the serial label for the machine weight.

Transport and Lifting Instructions

- ☑ Be sure the turntable is secured with the turntable rotation lock before transporting. Be sure to unlock the turntable for operation.
- ☑ Do not drive the machine on a slope that exceeds the slope or side slope rating. See Driving on a Slope in the Operating Instructions section.
- ☑ If the slope of the transport vehicle bed exceeds the uphill or downhill maximum slope rating, the machine must be loaded and unloaded using a winch as described.

Free-wheel Configuration for Winching

Chock the wheels to prevent the machine from rolling.

Release the wheel brakes by turning over all four drive hub disconnect caps.

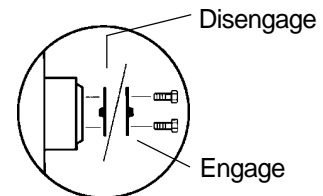

Be sure the winch line is properly secured to the drive chassis tie points and the path is clear of all obstructions.

Reverse the procedures described to re-engage the brakes.

Note: The pump free-wheel valve should always remain closed.

Transport and Lifting Instructions

Securing to Truck or Trailer for Transit

Always use the turntable rotation lock pin each time the machine is transported.

Turn the key switch to the off position and remove the key before transporting.

Inspect the entire machine for loose or unsecured items.

Securing the Chassis

Use chains of ample load capacity.

Use a minimum of 6 chains.

Adjust the rigging to prevent damage to the chains.

Securing the Platform

Place a block under the platform rotator. Do not allow the block to contact the platform cylinder.

Secure the platform with a nylon strap placed through the lower platform support. Do not use excessive downward force when securing the boom section.

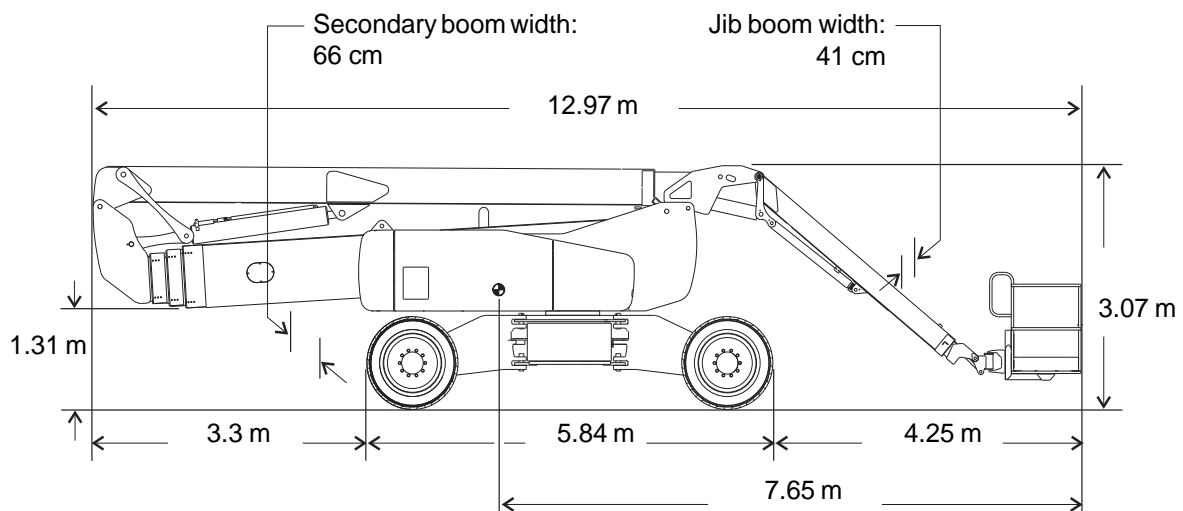
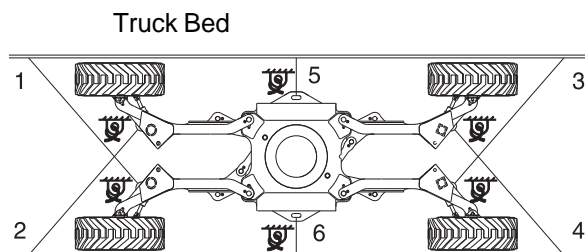
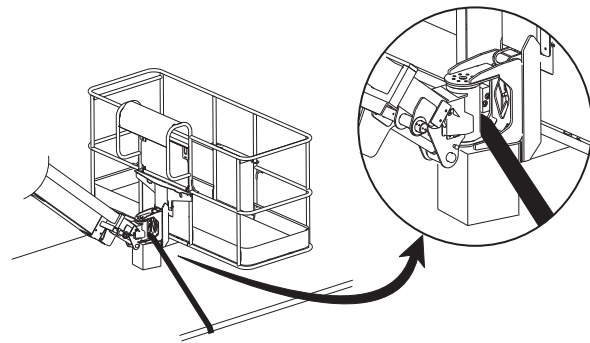

Transport and Lifting Instructions



Observe and Obey:

- ☑ Only qualified riggers should rig and lift the machine.
- ☑ Be sure the crane capacity, loading surfaces and straps or lines are sufficient to withstand the machine weight. See the serial label for the machine weight.

Lifting Instructions

Fully lower and retract the primary and secondary boom. Fully lower and retract the jib boom. Remove all loose items on the machine.

Determine the center of gravity of your machine using the picture on this page.

Attach the rigging only to the designated lifting points on the machine. There are four lifting points on the chassis.

Adjust the rigging to prevent damage to the machine and to keep the machine level.

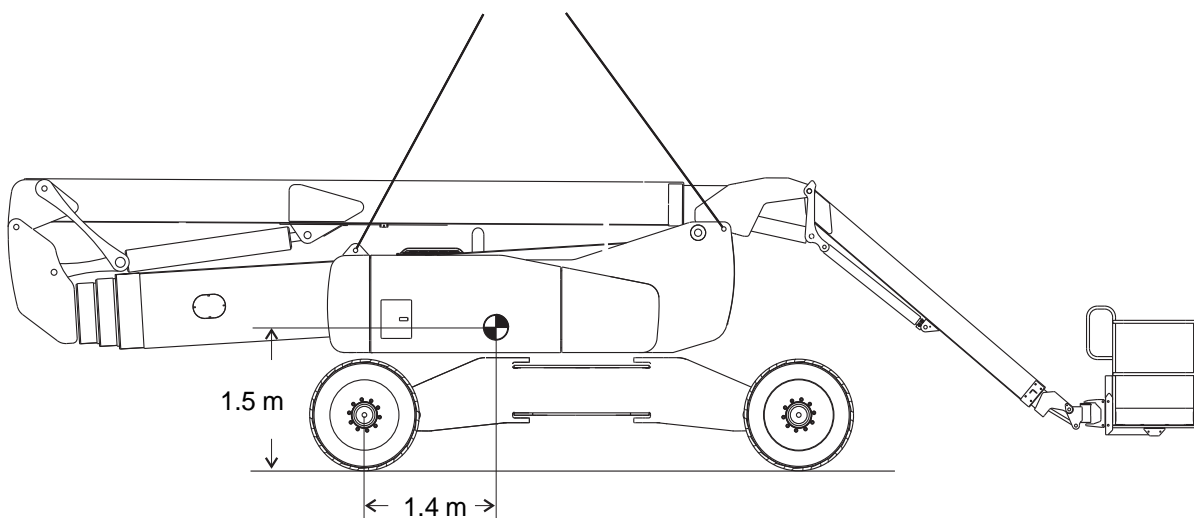

Maintenance



Observe and Obey:

- Only routine maintenance items specified in this manual shall be performed by the operator.
- Scheduled maintenance inspections shall be completed by qualified service technicians, according to the manufacturer's specifications and the requirements specified in the responsibilities manual.
- Use only Genie approved replacement parts.

Maintenance Symbols Legend

The following symbols have been used in this manual to help communicate the intent of the instructions. When one or more of the symbols appear at the beginning of a maintenance procedure, it conveys the meaning below.



Indicates that tools will be required to perform this procedure.



Indicates that new parts will be required to perform this procedure.



Indicates that a cold engine is required before performing this procedure.

Check the Engine Oil Level



Maintaining the proper engine oil level is essential to good engine performance and service life. Operating the machine with an improper oil level can damage engine components.

Note: Check the oil level with the engine off.

- 1 Check the engine oil dipstick. Add oil as needed.

Perkins 1104C-44 Engine

Oil type	15W-40
Oil type - cold conditions	10W-30

Deutz BF4L2011 Engine

Oil type	15W-40
Oil type - cold conditions	5W-30

Cummins B4.5C80 Engine

Oil type	15W-40
Oil type - cold conditions	10W-30



Maintenance

Check the Hydraulic Oil Level



Maintaining the hydraulic oil at the proper level is essential to machine operation. Improper hydraulic oil levels can damage hydraulic components. Daily checks allow the inspector to identify changes in the oil level that might indicate the presence of hydraulic system problems.

- 1 Be sure that the engine is off and the boom is in the stowed position.
- 2 Visually inspect the sight gauge located on the side of the hydraulic oil tank.
- ⊙ Result: The hydraulic oil level should be between the two marks on the decal next to the sight gauge. Add oil as needed.



Hydraulic oil specifications

Hydraulic oil type	Chevron Rykon® Premium MV equivalent
--------------------	---

Check the Batteries



Proper battery condition is essential to good engine performance and operational safety. Improper fluid levels or damaged cables and connections can result in engine component damage and hazardous conditions.

- ⚠ Electrocutation hazard. Contact with hot or live circuits may result in death or serious injury. Remove all rings, watches and other jewelry.
- ⚠ Bodily injury hazard. Batteries contain acid. Avoid spilling or contacting battery acid. Neutralize battery acid spills with baking soda and water.

- 1 Put on protective clothing and eye wear.
- 2 Be sure that the battery cable connections are tight and free of corrosion.
- 3 Be sure that the battery hold-down bar is in place and secure.
- 4 Remove the battery vent caps.
- 5 Check the battery acid level. If needed, replenish with distilled water to the bottom of the battery fill tube. Do not overfill.
- 6 Install the vent caps.

Note: Adding terminal protectors and a corrosion preventative sealant will help eliminate corrosion on the battery terminals and cables.



Maintenance

Check the Engine Coolant Level - Liquid Cooled Models



Maintaining the engine coolant at the proper level is essential to engine service life. An improper coolant level will affect the engine's cooling capability and damage engine components. Daily checks will allow the inspector to identify changes in coolant level that might indicate cooling system problems.

- 1 Check the fluid level in the coolant recovery tank. Add fluid as needed.

⦿ Result: The fluid level should be in the NORMAL range.

⚠ Bodily injury hazard. Fluids in the radiator are under pressure and extremely hot. Use caution when removing cap and adding fluids.

Scheduled Maintenance

Maintenance performed quarterly, annually and every two years must be completed by a person trained and qualified to perform maintenance on this machine according to the procedures found in the service manual for this machine.

Machines that have been out of service for more than three months must receive the quarterly inspection before they are put back into service.



Specifications

Z-135/70	
Height, working maximum	42.9 m
Height, platform maximum	41.1 m
Height, stowed maximum	3.1 m
Horizontal reach, maximum	21.3 m
Width, axles retracted	2.5 m
Width, axles extended	3.9 m
Length, stowed	12.9 m
Maximum load capacity	272 kg
Maximum wind speed	12.5 m/s
Wheelbase, axles extended	4.1 m
Wheelbase, axles retracted	4.7 m
Ground clearance	51 cm
Turning radius, axles extended inside	2.3 m
outside	5.6 m
Turning radius, axles retracted inside	5.5 m
outside	7.8 m
Turntable rotation	360° continuous
Turntable tailswing, secondary boom lowered	4.3 m
Turntable tailswing, secondary boom raised	78 cm
Drive speed, stowed	4.8 km/h 12.2 m/9.1 sec
Drive speed, raised or extended	1.1 km/h 12.2 m/40 sec
Drive speed, raised and extended	0.6 km/h 12.2 m/68 sec
Controls	12V DC proportional
Platform dimensions, 1.8 m (length x width)	1.8 m x 76 cm
Platform dimensions, 2.4 m (length x width)	2.4 m x 91 cm

Platform leveling	self-leveling
Platform rotation	160°
AC outlet in platform	standard
Hydraulic pressure, maximum (boom functions)	203 bar
Hydraulic pressure, maximum (auxiliary power unit)	218 bar
System voltage	12V
Tire size	18-22.5, 18 ply FF
Fuel tank capacity	151 liters
Weight (Machine weights vary with option configurations)	See Serial Label
Airborne noise emissions	113 dB
Maximum sound level at normal operating workstations (A-weighted)	
Vibration value does not exceed 2.5 m/s ²	
Maximum slope rating, stowed position	
Counterweight uphill	45% (24°)
Counterweight downhill	30% (17°)
Side slope	25% (14°)
Note: Slope rating is subject to ground conditions and adequate traction.	

Floor loading information

Tire load, maximum	11,336 kg
Tire contact pressure	9.14 kg/cm ² 896 kPa
Occupied floor pressure	996 kg/m ² 9.76 kPa

Note: Floor loading information is approximate and does not incorporate different option configurations. It should be used only with adequate safety factors.

Continuous improvement of our products is a Genie policy. Product specifications are subject to change without notice or obligation.

Specifications

Z-135/70 Range of Motion

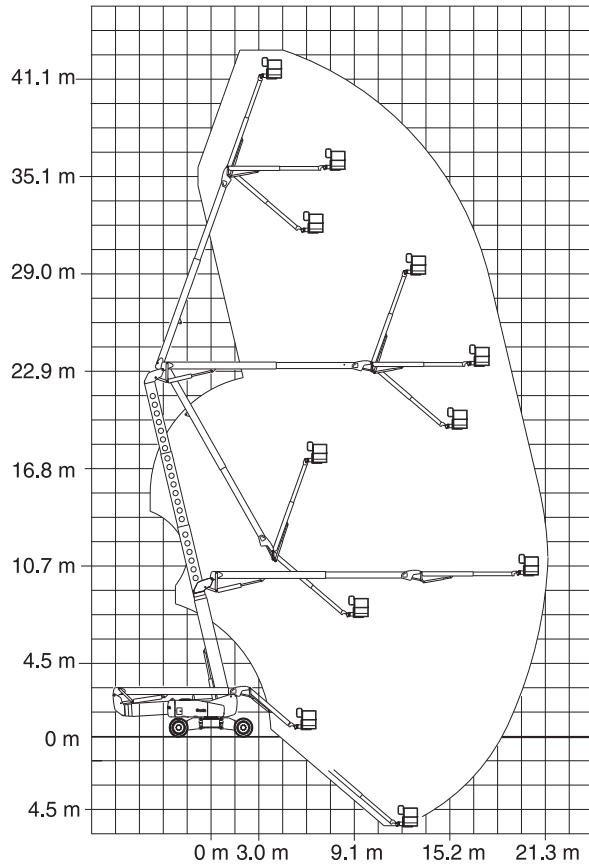



California Proposition 65

Warning

The exhaust from this product contains chemicals known to the State of California to cause cancer, birth defects or other reproductive harm.

Distributed By:

Genie North America

Phone 425.881.1800
Toll Free USA and Canada
800.536.1800
Fax 425.883.3475

Genie Australia Pty Ltd.

Phone +61 7 3375 1660
Fax +61 7 3375 1002

Genie China

Phone +86 21 53852570
Fax +86 21 53852569

Genie Malaysia

Phone +65 98 480 775
Fax +65 67 533 544

Genie Japan

Phone +81 3 3453 6082
Fax +81 3 3453 6083

Genie Korea

Phone +82 25 587 267
Fax +82 25 583 910

Genie Brasil

Phone +55 11 41 665 755
Fax +55 11 41 665 754

Genie Holland

Phone +31 183 581 102
Fax +31 183 581 566

Genie Scandinavia

Phone +46 31 575100
Fax +46 31 579020

Genie France

Phone +33 (0)2 37 26 09 99
Fax +33 (0)2 37 26 09 98

Genie Iberica

Phone +34 93 579 5042
Fax +34 93 579 5059

Genie Germany

Phone +49 (0)4202 88520
Fax +49 (0)4202 8852-20

Genie U.K.

Phone +44 (0)1476 584333
Fax +44 (0)1476 584334

Genie Mexico City

Phone +52 55 5666 5242
Fax +52 55 5666 3241